

Light efficiency:

**109 Lumen/Watt**

Light quality:

**CRI: 84,3**

Color temperature:

**3100 K**

**116,9°**

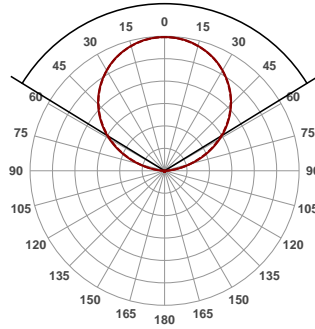

Product name:

**Demo panel explorer 2**

Item number:

**PO130035**

Date and time:

**14-01-2016 13:36:22**

**Output: 1200 Lumen Power consumption: 11,0**

Spectral distribution

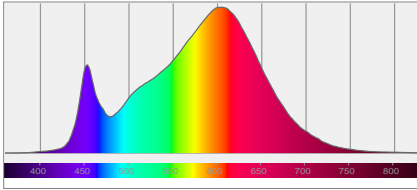

Color coordinates

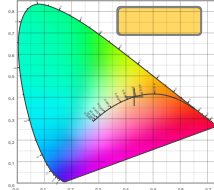

White color point

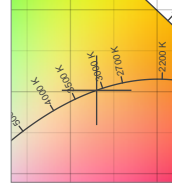

CRI R values

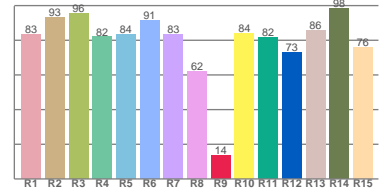

Color temperature	Color rendering index	Red component	Color fidelity	Color gamut	Color quality scale	Color coordinate cie 1931	Color coordinate cie 1931	Color coordinate	Color coordinate	Color deviation from black body
CCT	CRI	CRI R9	TM30 Rf	TM30 Rg	CQS	x	y	u	v	Δuv
3100 K	84,3	13,8	84,1	95,4	83,6	0,430	0,402	0,246	0,345	0,0008

**Beam details**

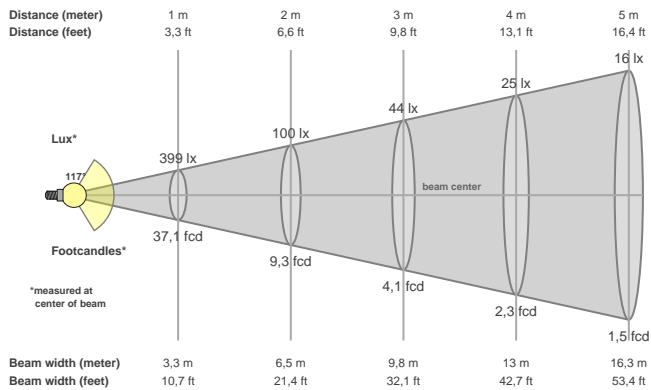

**Beam angles**

Beam angle 50%	Field angle 10%	Cutoff angle 2,5%
<b>116,9°</b>	<b>161,9°</b>	<b>174°</b>

**Beam intensities**

Peak intensity	Int. ratio in 120° cone	Int. ratio in 90° cone
<b>399 cd</b>	<b>77,7%</b>	<b>52,2%</b>

**Beam intensities from 1-20m**

1m	2m	3m	4m	5m	6m	7m	8m	9m	10m	11m	12m	13m	14m	15m	16m	17m	18m	19m	20m
3,3ft	6,6ft	9,8ft	13,1ft	16,4ft	19,7ft	23ft	26,2ft	29,5ft	32,8ft	36,1ft	39,4ft	42,7ft	45,9ft	49,2ft	52,5ft	55,8ft	59,1ft	62,3ft	65,6ft
399lx	100lx	44lx	25lx	16lx	11lx	8lx	6lx	5lx	4lx	3lx	3lx	2lx	2lx	2lx	2lx	1lx	1lx	1lx	1lx
37,1fcd	9,3fcd	4,1fcd	2,3fcd	1,5fcd	1fcd	0,8fcd	0,6fcd	0,5fcd	0,4fcd	0,3fcd	0,3fcd	0,2fcd	0,2fcd	0,2fcd	0,1fcd	0,1fcd	0,1fcd	0,1fcd	0,1fcd

**Power scope**

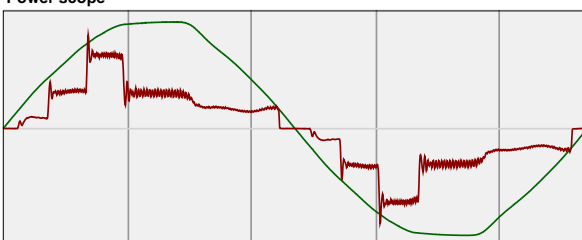

Power	Power factor	Power frequency
<b>11,0 W</b>	<b>0,91</b>	<b>50 Hz</b>

Nominal voltage	Voltage	Current
<b>230 V</b>	<b>227 V</b>	<b>0,053 A</b>